

Kalıp ve İskele Sistemleri

Formwork & Scaffolding Systems



Ürün kataloğu
Product catalog

1984 ✓

Tırmanır şaft platformu SH

Climbing shaft platform

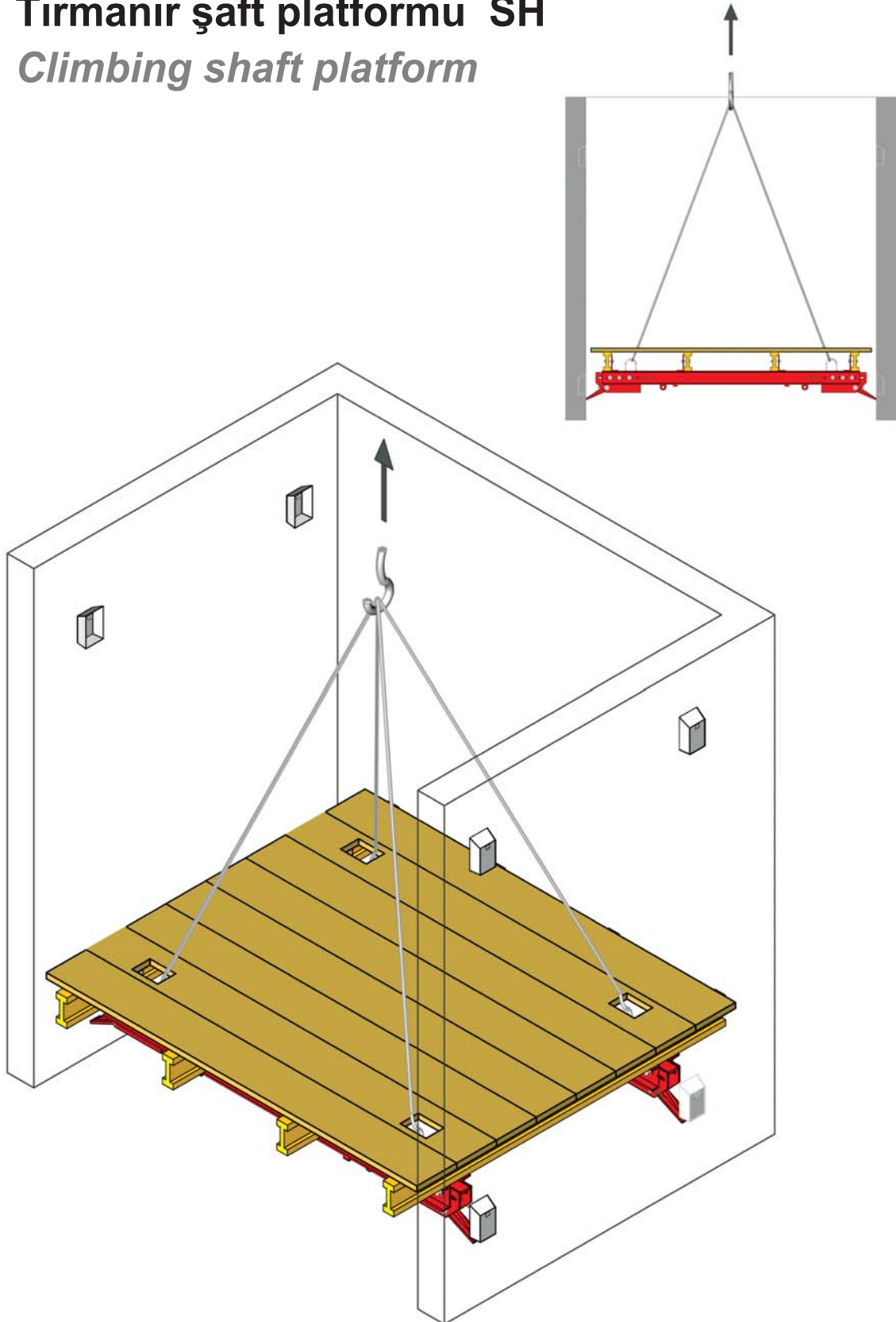

Tırmanır şaft platformu SH

Climbing shaft platform

Platform kirişleri SH / Platform beams SH

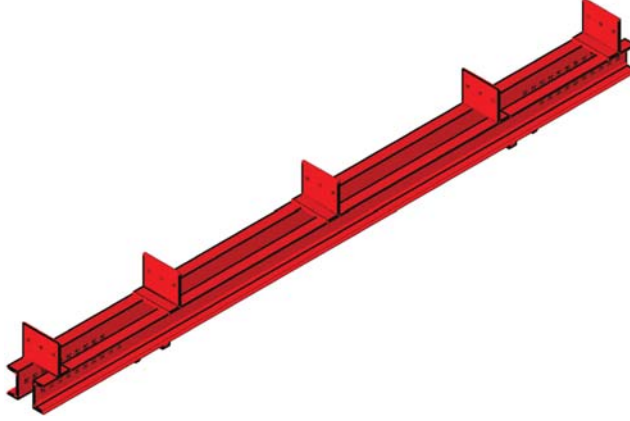

	G=min-max	parça / item no	kg
SH12 100	115/140 cm	056 7100	32,70
SH12 120	130/160 cm	056 7120	40,00
SH12 150	160/190 cm	056 7150	51,00
SH12 160	170/200 cm	056 7160	53,70
SH12 190	200/230 cm	056 7190	62,20
SH12 220	230/260 cm	056 7220	74,00
SH12 250	260/290 cm	056 7250	82,70
SH12 280	290/320 cm	056 7280	93,20
SH12 290	300/330 cm	056 7290	96,00
SH14 300	310/340 cm	056 7300	114,70
SH14 330	340/370 cm	056 7330	124,30
SH14 360	370/400 cm	056 7360	134,00
SH14 390	400/430 cm	056 7390	149,70
SH16 400	410/440 cm	056 7400	172,00
SH16 430	440/470 cm	056 7430	183,00
SH16 460	470/500 cm	056 7460	198,00
SH16 490	500/530 cm	056 7490	209,00
SH16 520	530/560 cm	056 7520	223,00
SH16 550	560/590 cm	056 7550	235,00
SH16 580	590/620 cm	056 7580	248,00
SH16 600	610/640 cm	056 7600	256,00

Özel boyda kiriş imalatımız mevcuttur / Special lengths are available if required

Kiriş adaptör kutusu SH / Beam adapter box SH



056 7692 18,20

Mafsallı başlık SH / Articulated head SH

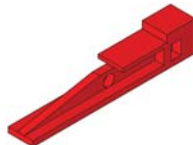





056 7693 9,20

Aksesuar elemanı: SH başlık pimi 1 tk. / Accessory: 1 set of SH pin

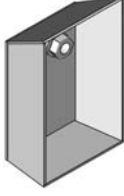
Tırmanır şaft platformu SH

Climbing shaft platform

Rezervasyon kutusu SH / Reservation box SH		parça / item no	kg
 M24/80 civata ile birlikte / Complete with M24/80 bolt		056 7694	1,50
Mafsallı başlık pimi SH / Pin for articulated head SH		005 2814	1,00
			
Kaldırma kancası SH / Crane hook SH		005 8494	0,50
			
Ahşap vidalar / Wood screws			
	M6/60	005 0660	0,007
	M6/80	005 0680	0,008
	M8/60	005 0860	0,008
	M8/80	005 0880	0,009
			
Somun ve civatalar / Screws & nuts			
	M8/120	005 0812	0,05
	M16/150	005 1615	0,25
	M18/80	005 1808	0,18
			

Tırmanır Őaft platformu SH
Climbing shaft platform



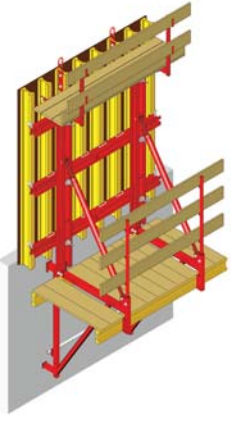

MAK

Mühendislik Sanayi ve Ticaret Ltd. Őti.

Büro/Office: Őerefli Sokak No: 34/2 Tandođan-ANKARA/TÜRKİYE

Tel: + 90 312 223 40 58 - 223 70 08

Fax: + 90 312 213 70 87

GSM: + 90 530 644 73 23

Fabrika/Factory: Eski İstanbul Yolu 25. Km. Sarayköy / ANKARA

mak@mak.com.tr www.mak.com.tr