

Kalıp ve İskele Sistemleri

Formwork & Scaffolding Systems



Ürün kataloğu
Product catalog

1984 ✓

Dairesel perde kalıbı H20

Circular wall form

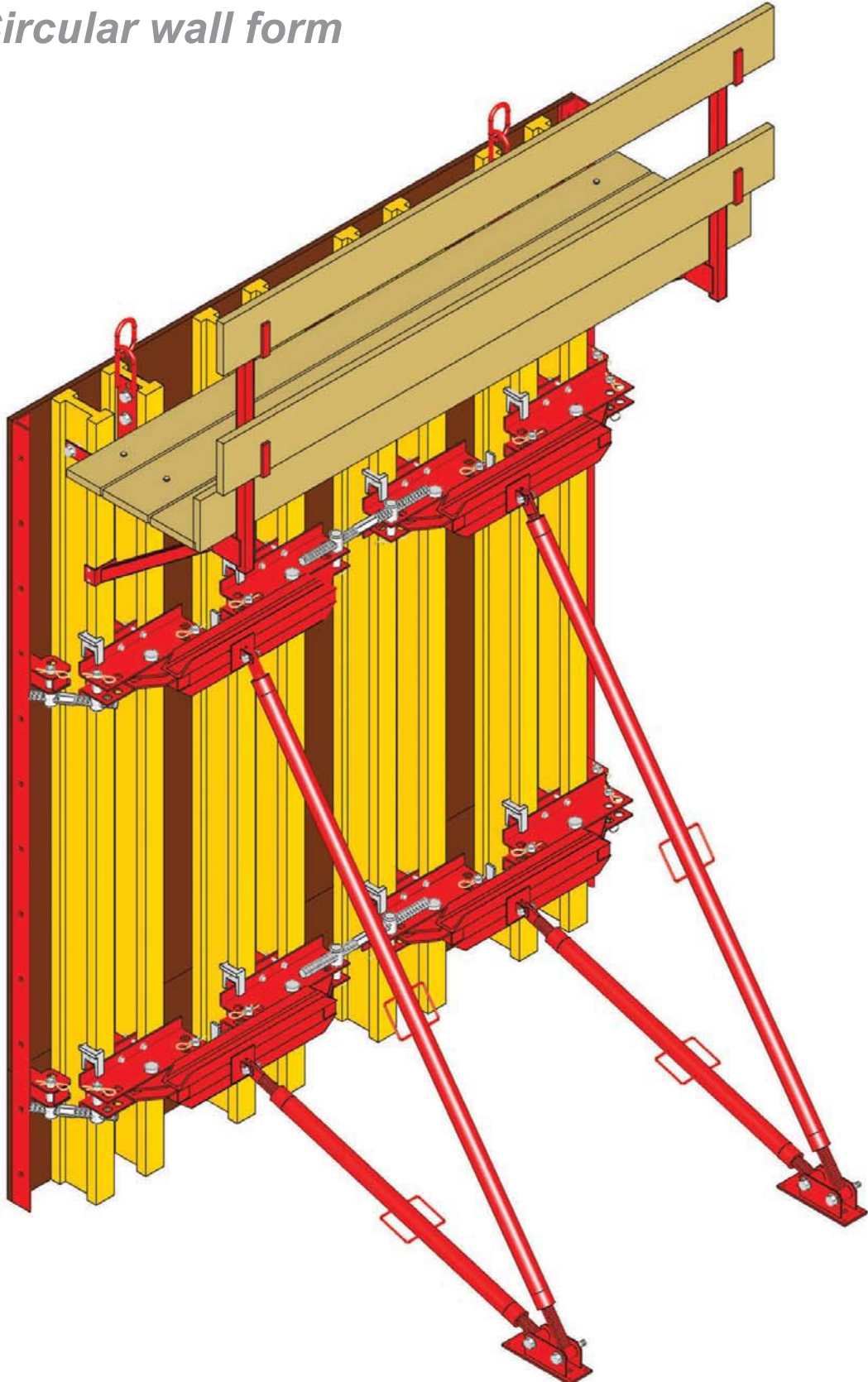

Dairesel perde kalıbı H20 *Circular wall form*







Dairesel perde kalıbı H20

Circular wall form



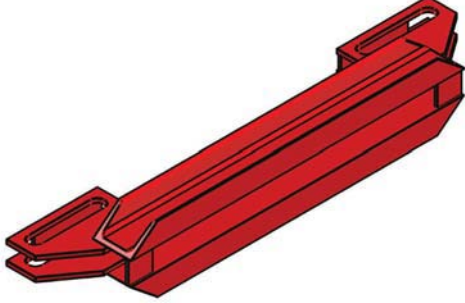
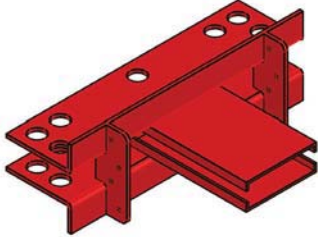





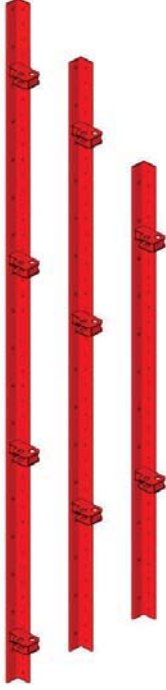

Dairesel perde kalıbı H20

Circular wall form

Bükme kuşağı / Waling	parça / item no	kg	
	053 0027	14,30	
T - kuşak / T - waler			
45 cm	063 0001	9,00	
80 cm	063 0002	14,40	
			
Ayar mili 55 cm / Adjustable spindle 55 cm			
Sağ-sol ayar somunları ile birlikte / Complete with right & left nuts	55 cm	005 5500	5,30
			
Aksesuar elemanı: R kupilya / Accessories: R pin			
Ayar mili 25 cm / Adjustable spindle 25 cm			
Sağ-sol ayar somunları ile birlikte / Complete with right & left nuts	25 cm	005 2500	3,50
			
Aksesuar elemanı: R kupilya / Accessories: R pin			
Kuşak pimi / Waling bolt			
	005 0001	0,58	
Aksesuar elemanı: R kupilya / Accessories: R pin			

Dairesel perde kalıbı H20

Circular wall form

Kenar profili / Edge profile		parça / item no	kg
	590 cm	053 0590	63,15
	490 cm	053 0490	52,25
	450 cm	053 0450	48,40
	390 cm	053 0390	41,35
	360 cm	053 0360	38,45
	330 cm	053 0330	35,60
	290 cm	053 0290	30,45
	265 cm	053 0265	28,05
	245 cm	053 0245	26,10
	215 cm	053 0215	23,25
	120 cm	053 0120	12,80
	60 cm	053 0060	7,05
	Bağlantı laması / Connection plate		
		063 0003	0,50
2 tk. M9/80 somun civata ile birlikte / Complete with 2 sets of M9/80			
H20 klips / H20 clips			
		004 1141	0,70
R kupilya / R pin			
		005 0993	0,01
Sunta vidası 6/60 / Plywood screw 6/60			
		005 0660	0,007
Plywood civatası M9/35 / Plywood bolt M9/35			
		005 0905	0,037
Profil civatası M16 / Profile bolt M16			
	L=100 mm	005 1610	0,21
	L= 40 mm	005 1604	0,12

Vinç askı seti / Crane splice

parça / Item no

kg

2 tk. M16/60 somun civata ile birlikte / Complete with 2 sets of M16/60



060 0011

4,20

H20 uzatma elemanı / H20 extension splice

4 tk. M16/60 somun civata ile birlikte / Complete with 4 sets of M16/60

67 cm



060 0012

5,30

Konsol H20 / Console H20

1 tk. M16/120 somun civata ile birlikte / Complete with 1 set of M16/120

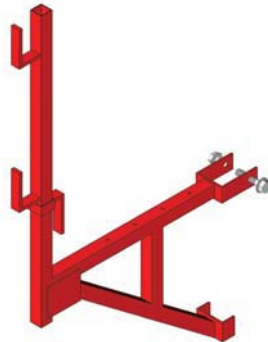

070 0011

11,00

Aksesuar elemanı: 3 tk. M8/120 / Accessories: 3 sets of M8/120

M8/120 somun civata / M8/120 screw & nut



005 0812

0,05

Dairesel perde kalıbı H20

Circular wall form

Payanda / Push - pull prop

parça / item no kg



110/200 cm	070 0110	12,90
160/250 cm	070 0160	15,05
210/300 cm	070 0210	17,20
260/350 cm	070 0260	19,30
310/400 cm	070 0310	21,45
360/450 cm	070 0360	23,55
410/500 cm	070 0410	37,65
510/600 cm	070 0510	43,00
610/700 cm	070 0610	55,00
710/800 cm	070 0710	60,50
810/900 cm	070 0810	88,00
610/1000 cm	070 0611	102,00

Payanda başlığı 80 / Prop head plate 80

1 tk. M16/60 somun civata ile birlikte / Complete with 1 set of M16/60



Aksesuar elemanı: Kama K 1 ad. / Accessories: Wedge K 1 pcs

060 0018 1,60

Payanda alt başlığı / Prop base plate

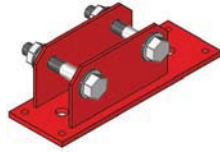

2 tk. M16/100 somun civata ile birlikte / Complete with 2 sets of M16/100

060 0016 4,00







Kama K / Wedge K

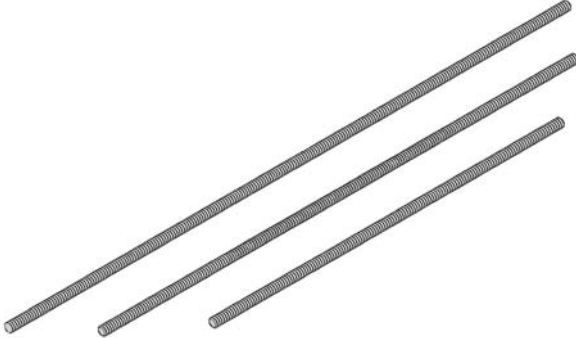

060 0014 0,30

Dairesel perde kalıbı H20

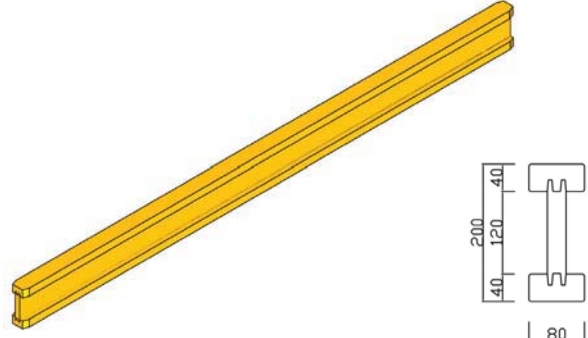
Circular wall form

Tie - rod \varnothing 17 mm		parça / item no	kg
	20 cm	017 0020	0,30
	30 cm	017 0030	0,43
	100 cm	017 0100	1,44
	120 cm	017 0120	1,73
	125 cm	017 0125	1,80
	135 cm	017 0135	1,94
	150 cm	017 0150	2,16
	180 cm	017 0180	2,59
	200 cm	017 0200	2,88
	225 cm	017 0225	3,24
	250 cm	017 0250	3,60
	270 cm	017 0270	3,89
	300 cm	017 0300	4,32
	350 cm	017 0350	5,00
	400 cm	017 0400	5,76
	450 cm	017 0450	6,48
Kelebek somun \varnothing 17 mm / <i>Wing nut \varnothing 17 mm</i>			
	D=10 cm	004 1161	0,61
	D = 5 cm	004 1168	0,30
Sac ayna / <i>Counter plate</i>			
	120*100*10 mm	004 0017	0,93
Su tutucu ara somun / <i>Waterstop</i>			
		004 1171	0,50
Ahşap kiriş H20 / <i>Wooden beam H20</i>			
	145 cm	007 0145	6,70
	190 cm	007 0190	8,80
	215 cm	007 0215	9,90
	245 cm	007 0245	11,30
	265 cm	007 0265	12,20
	290 cm	007 0290	13,40
	330 cm	007 0330	15,20
	360 cm	007 0360	16,60
	390 cm	007 0390	18,00
	420 cm	007 0420	19,30
	450 cm	007 0450	20,70
	490 cm	007 0490	22,60
550 cm	007 0550	25,30	
590 cm	007 0590	27,15	
Plywood / <i>Wooden beam H20</i>			
	15 mm	007 1500	
	18 mm	007 1800	

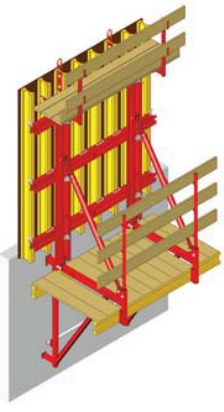

MAK

Mühendislik Sanayi ve Ticaret Ltd. Őti.

Büro/Office: Őerefli Sokak No: 34/2 Tandođan-ANKARA/TÜRKİYE

Tel: + 90 312 223 40 58 - 223 70 08

Fax: + 90 312 213 70 87

GSM: + 90 530 644 73 23

Fabrika/Factory: Eski İstanbul Yolu 25. Km. Sarayköy / ANKARA

mak@mak.com.tr www.mak.com.tr